

Constraints on chameleons and axion-like particles from the **GammeV** Experiment

Jason H. Steffen
Brinson Postdoctoral Fellow
Fermilab Center for Particle Astrophysics

IDM2008
Stockholm, Sweden
August 22, 2008



Aaron Chou
William Wester
Al Baumbaugh
Dick Gustafson
Yilda Irizarri-Valle
Peter Mazur

Jason Steffen
Ray Tomlin
Amol Upadhye
Amanda Weltman
Xi Yang
Jonghee Yoo

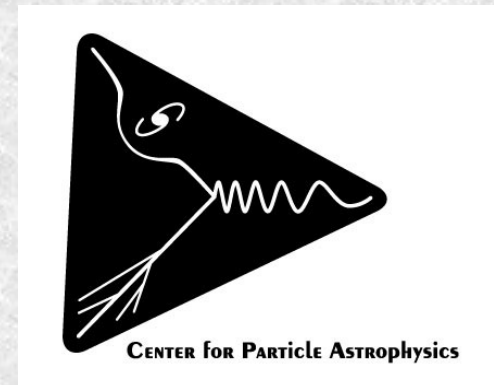

Outline

- GammeV – Axion
 - Light-shining-through-wall concept
 - GammeV results
- GammeV – Chameleon
 - Chameleon background information
 - Particle-in-a-jar concept
 - Chameleon results
- Future GammeV projects

Axions, the Other Dark Matter

Pseudoscalar coupling
to two photons.

$$\mathcal{L}_{\text{int}} = -\frac{1}{4} \frac{\phi}{M} F_{\mu\nu} \tilde{F}^{\mu\nu} = \frac{\phi}{M} (\vec{E} \cdot \vec{B})$$

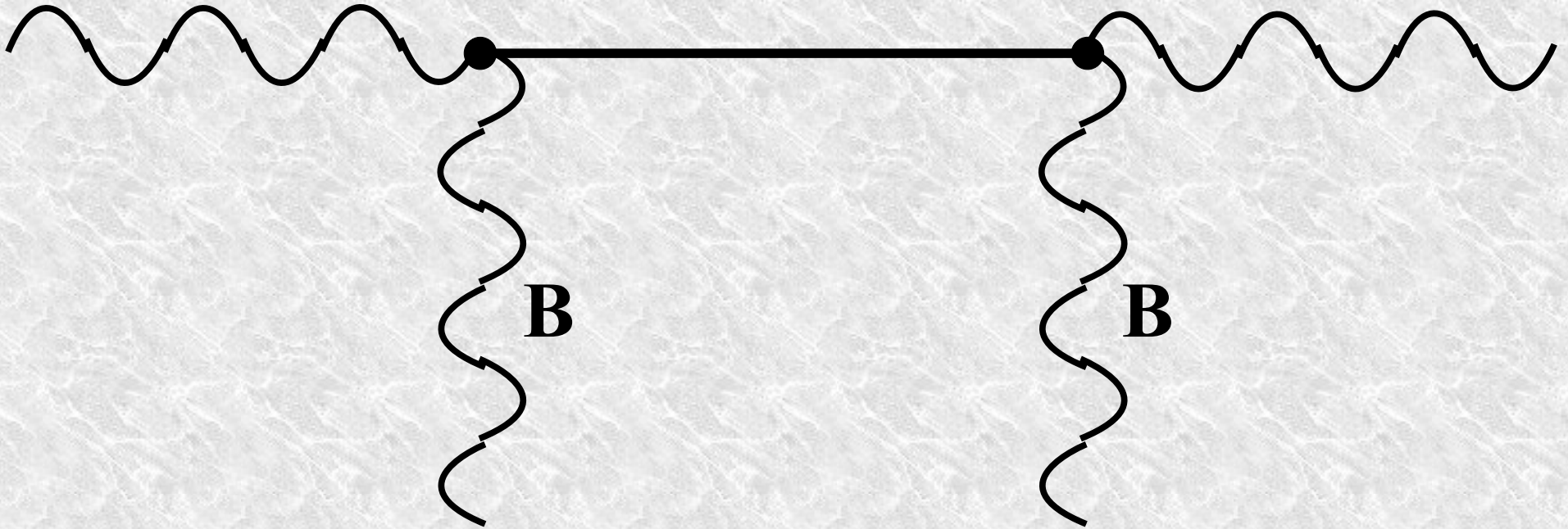

Axions, the Other Dark Matter

Pseudoscalar coupling
to two photons.

$$\mathcal{L}_{\text{int}} = -\frac{1}{4} \frac{\phi}{M} F_{\mu\nu} \tilde{F}^{\mu\nu} = \frac{\phi}{M} (\vec{E} \cdot \vec{B})$$

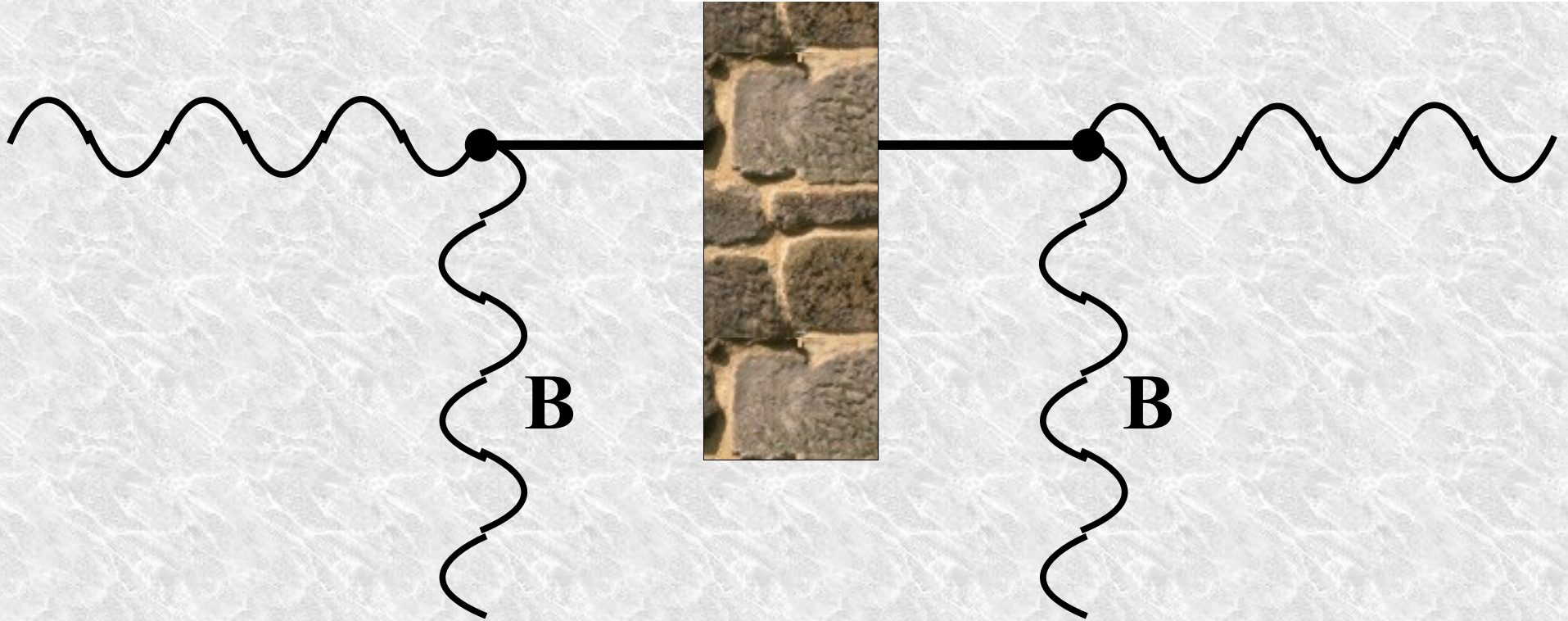

Axions, the Other Dark Matter

Pseudoscalar coupling
to two photons.

$$\mathcal{L}_{\text{int}} = -\frac{1}{4} \frac{\phi}{M} F_{\mu\nu} \tilde{F}^{\mu\nu} = \frac{\phi}{M} (\vec{E} \cdot \vec{B})$$

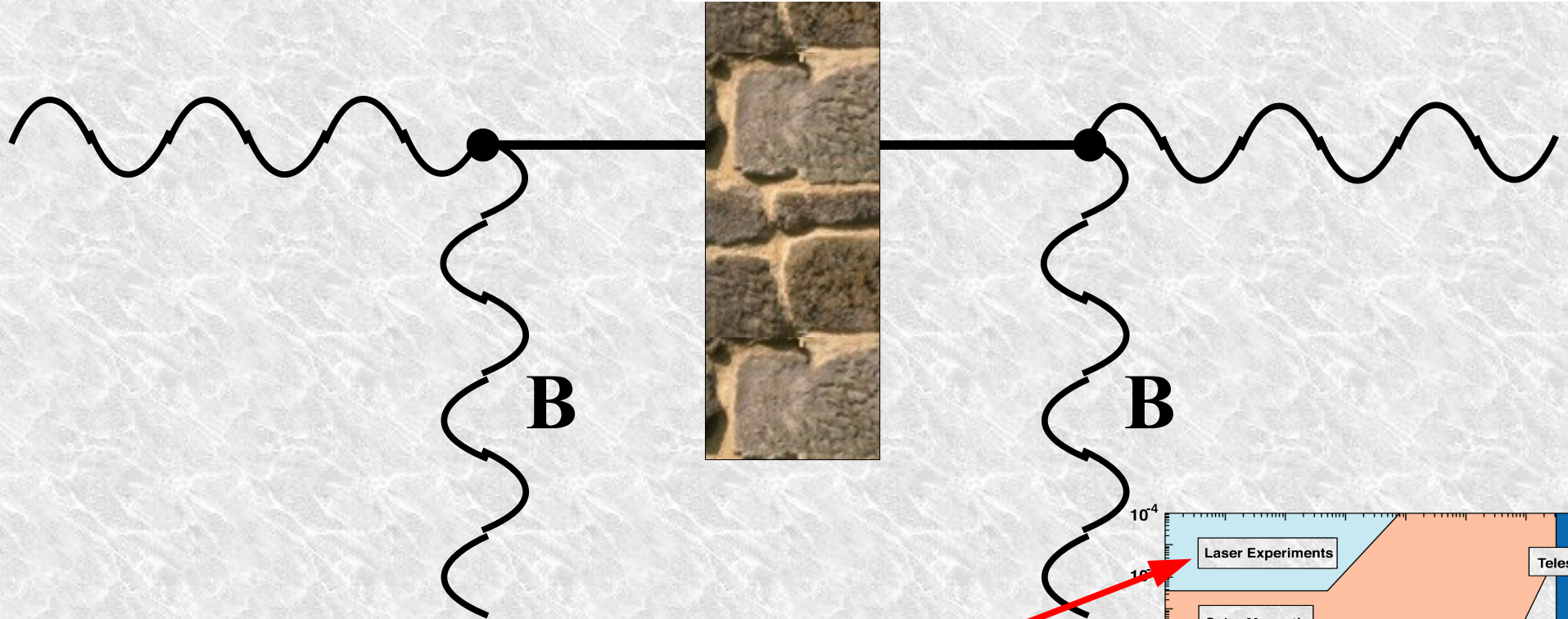

This process gives the “laser”
experimental results.
(BFRT Experiment)

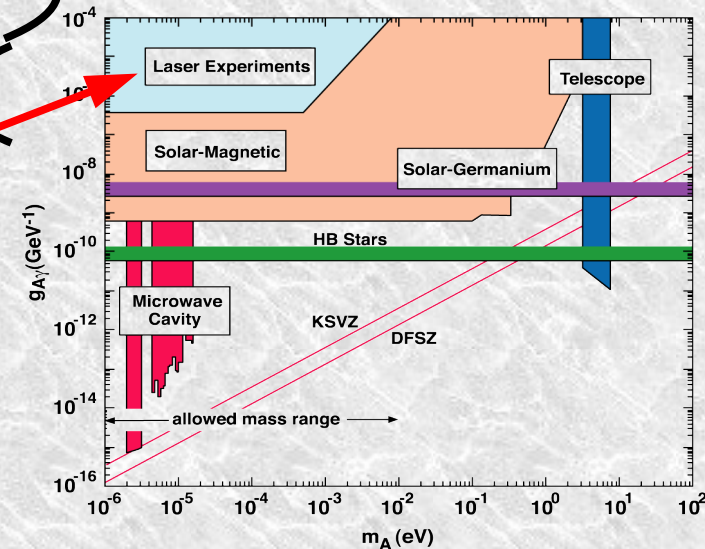

GammaV – Axion: Motivation

$$P_{\gamma \rightarrow \gamma} \simeq \frac{16B^4\omega^4g^4}{m_\phi^8} \sin^2\left(\frac{m_\phi^2 L_1}{4\omega}\right) \sin^2\left(\frac{m_\phi^2 L_2}{4\omega}\right)$$

- Fixed magnet length yields regions where sensitivity is reduced
- PVLAS parameters lie in a region of diminished BFRT sensitivity

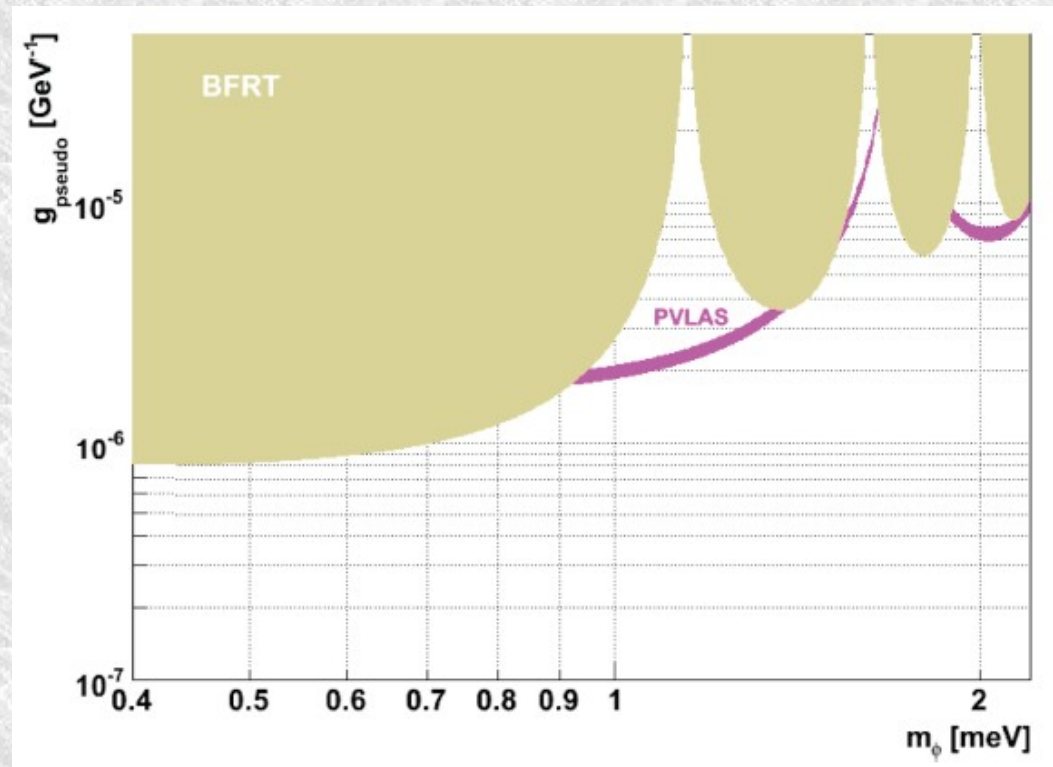

GammeV – Axion: Concept

- Plunger design allows us to adjust the lengths of the magnetic field regions
- Pulsed laser improves signal-to-noise ratio (~ 200)

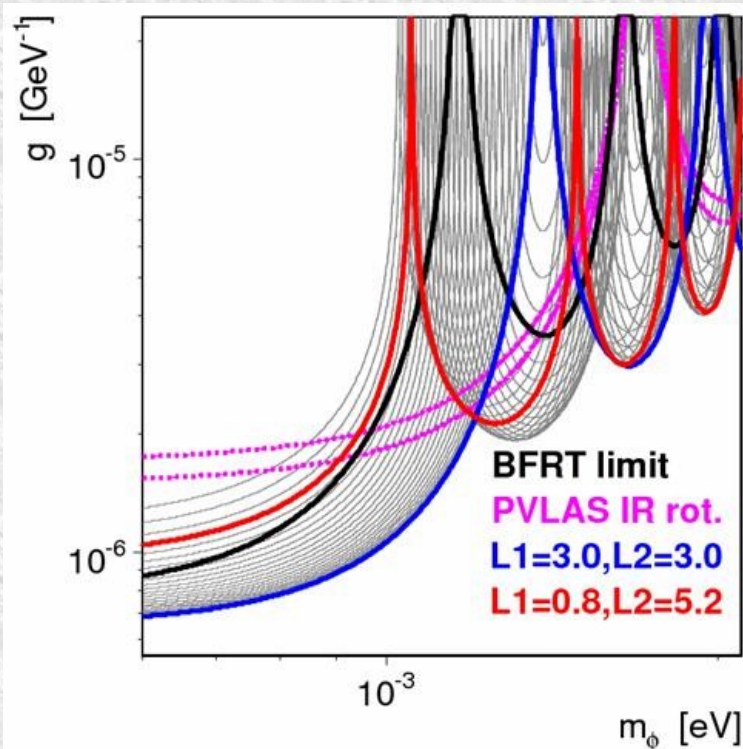
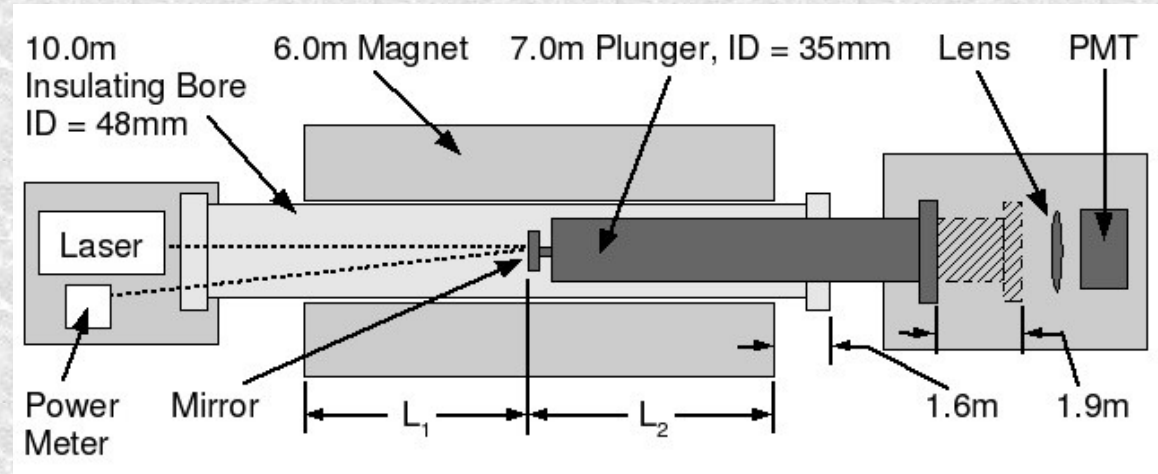

3-sigma limits after 5 hours

- Taking data in two different configurations allows us to probe the entire region surrounding the PVLAS signal

GammeV – Axion: Realization

Warm Bore

Magnet

Dark Box

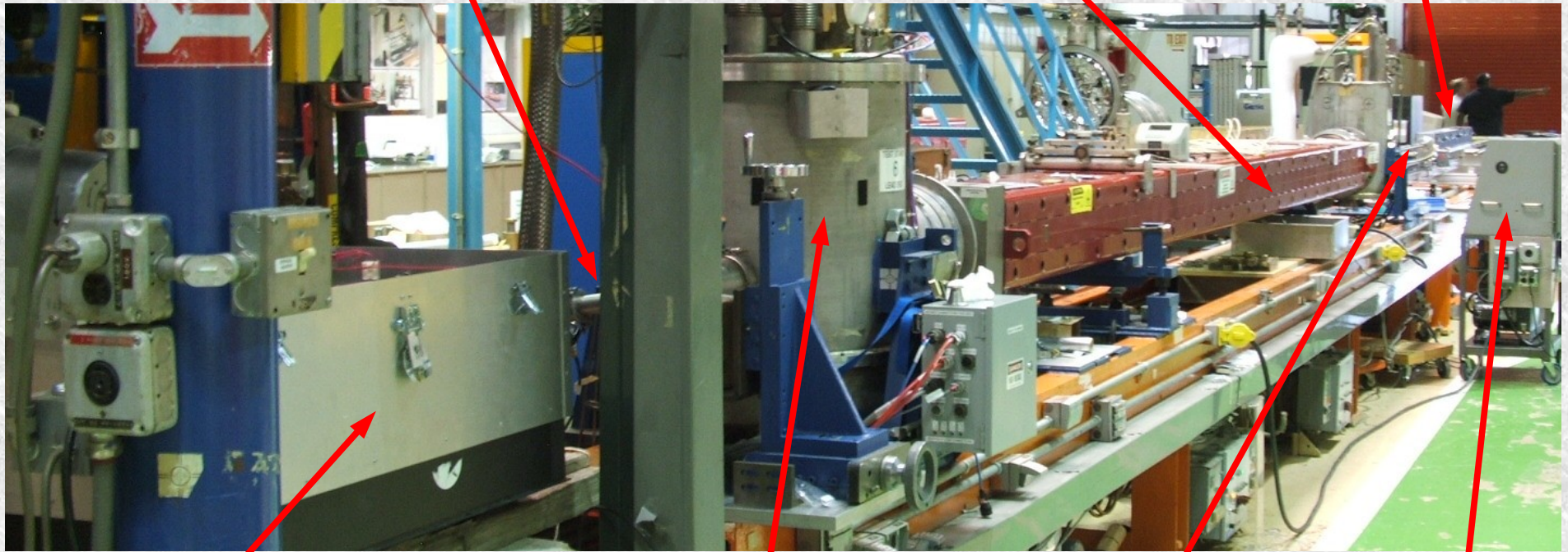

Laser Box

Cryogenic System

Plunger

Vacuum Pump

GammeV – Axion: Results

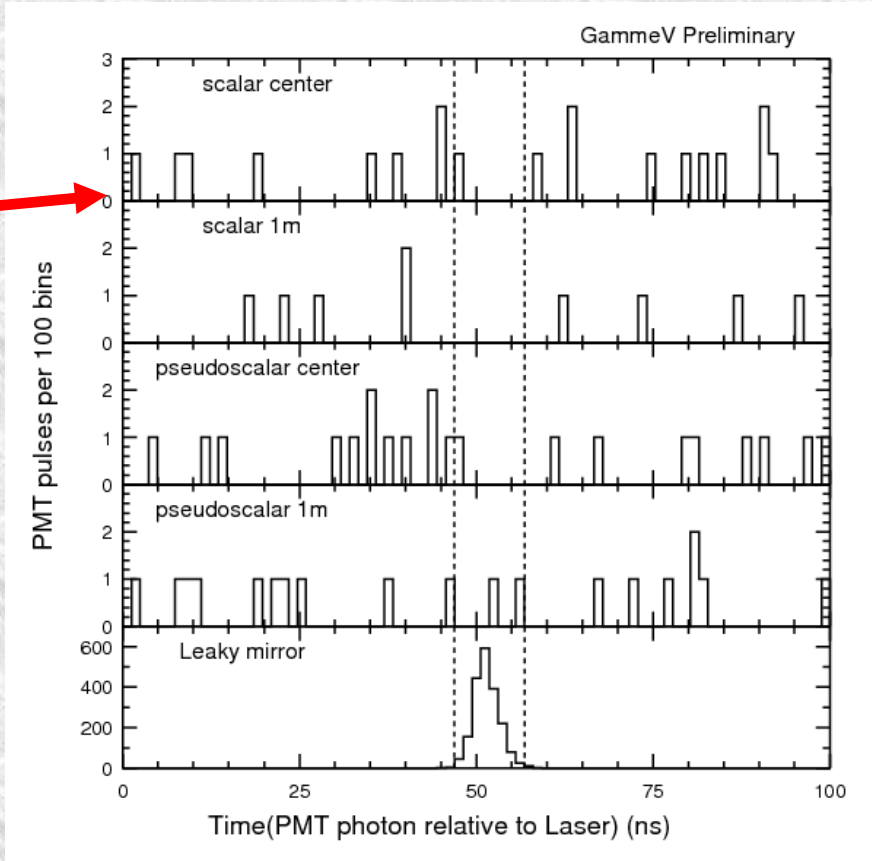
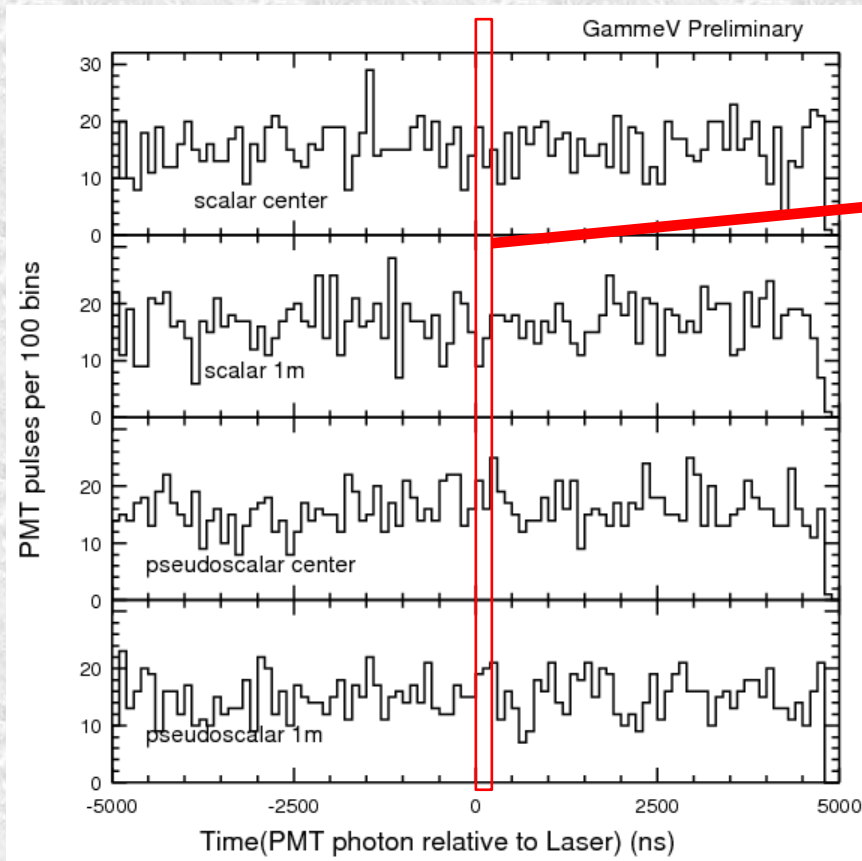

Spin	Position	# Laser pulse	# photons	Expected Background	Signal Candidates
Scalar	Center	1.34M	6.3e23	1.6	1
Scalar	1 m	1.47M	6.4e23	1.7	0
Pseudo	Center	1.43M	6.6e23	1.6	1
Pseudo	1m	1.47M	7.1e23	1.5	2

GammeV – Axion: Results

Pseudoscalar Limits

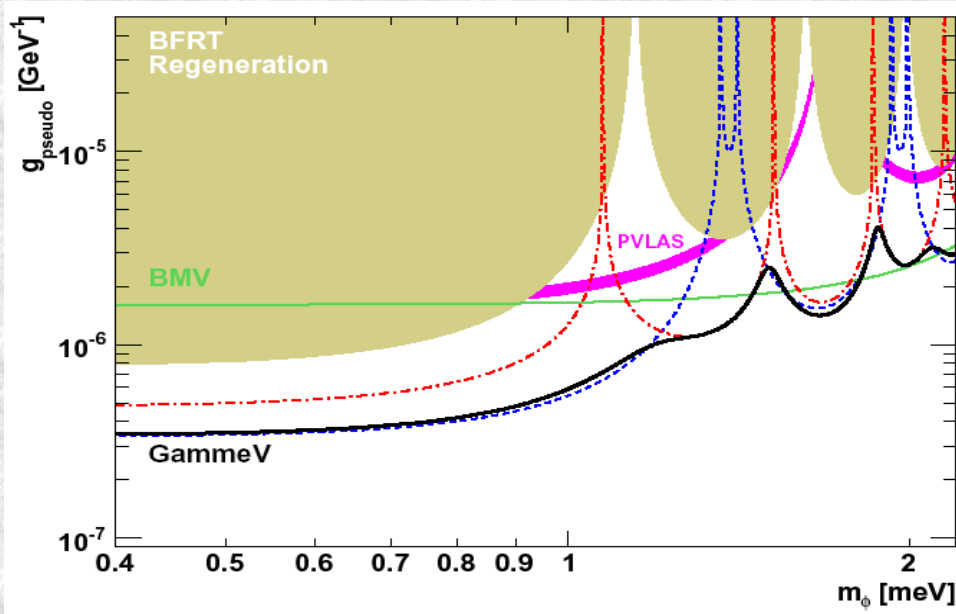

Scalar Limits

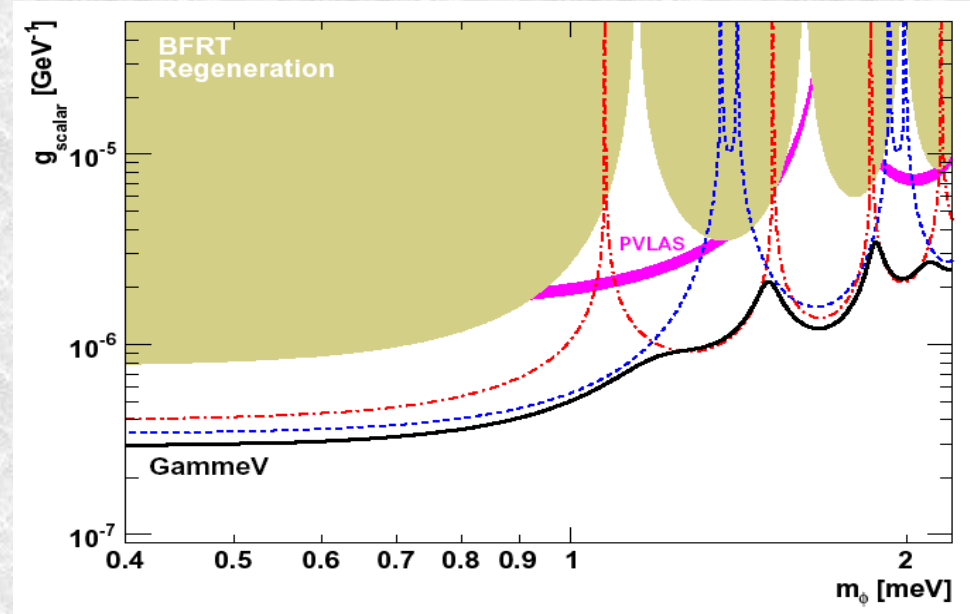

Tan region: BFRT 3-sigma exclusion
Pink region: PVLAS 3-sigma detection
Green line: BMV 3-sigma exclusion

Red line: **GammeV** 3-sigma exclusion center position
Blue line: **GammeV** 3-sigma exclusion edge position
Black line: **GammeV** 3-sigma combined limit

Chameleon Particles

- New scalar field with nontrivial potential and coupling to the energy–momentum tensor
- Mass is a strong function of the local energy density
- Hides the axions of string theory (Khoury/Weltman)
- Evades star cooling limits and tests of gravity

Sketch of chameleon mechanism: Low Density Background

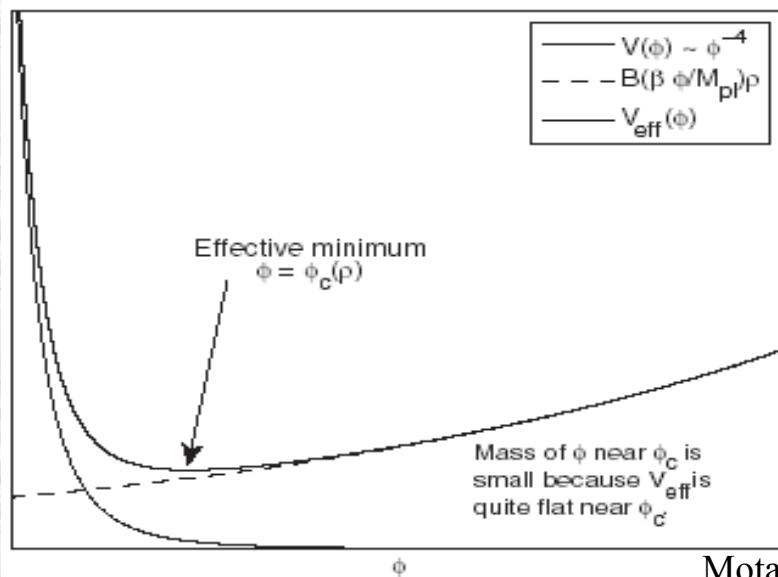

Sketch of chameleon mechanism: High Density Background

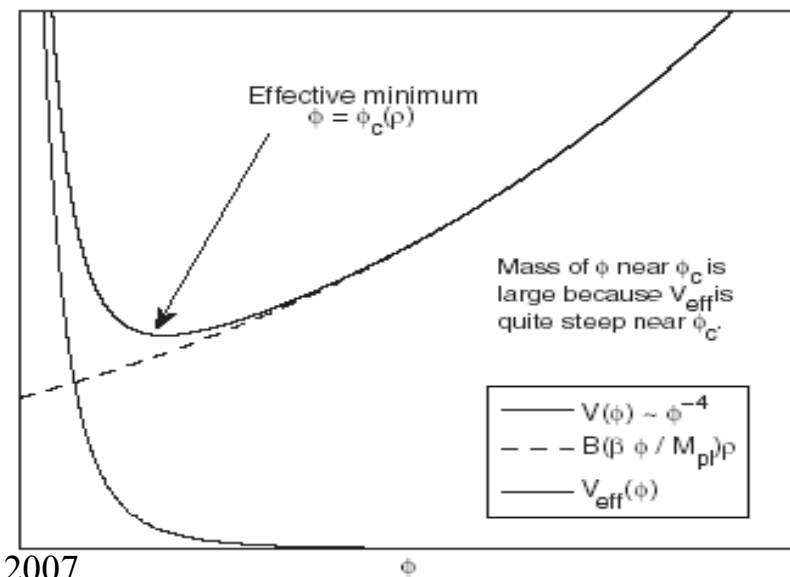

Mota & Shaw 2007

NB: The simplest models predict $m_{\text{eff}} \sim \rho^\alpha$.

GammeV – Chameleon: Concept

Strong matter effects cause the warm bore walls and vacuum windows to act like fully reflective mirrors.

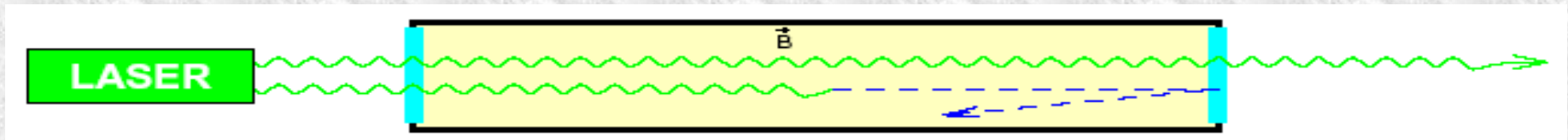

The laser shining into the cavity will fill the “jar” with chameleons.



After the jar is filled and the laser is turned off, you should see an afterglow as the chameleons reconvert to photons and escape.

GammaV – Chameleon: Concept

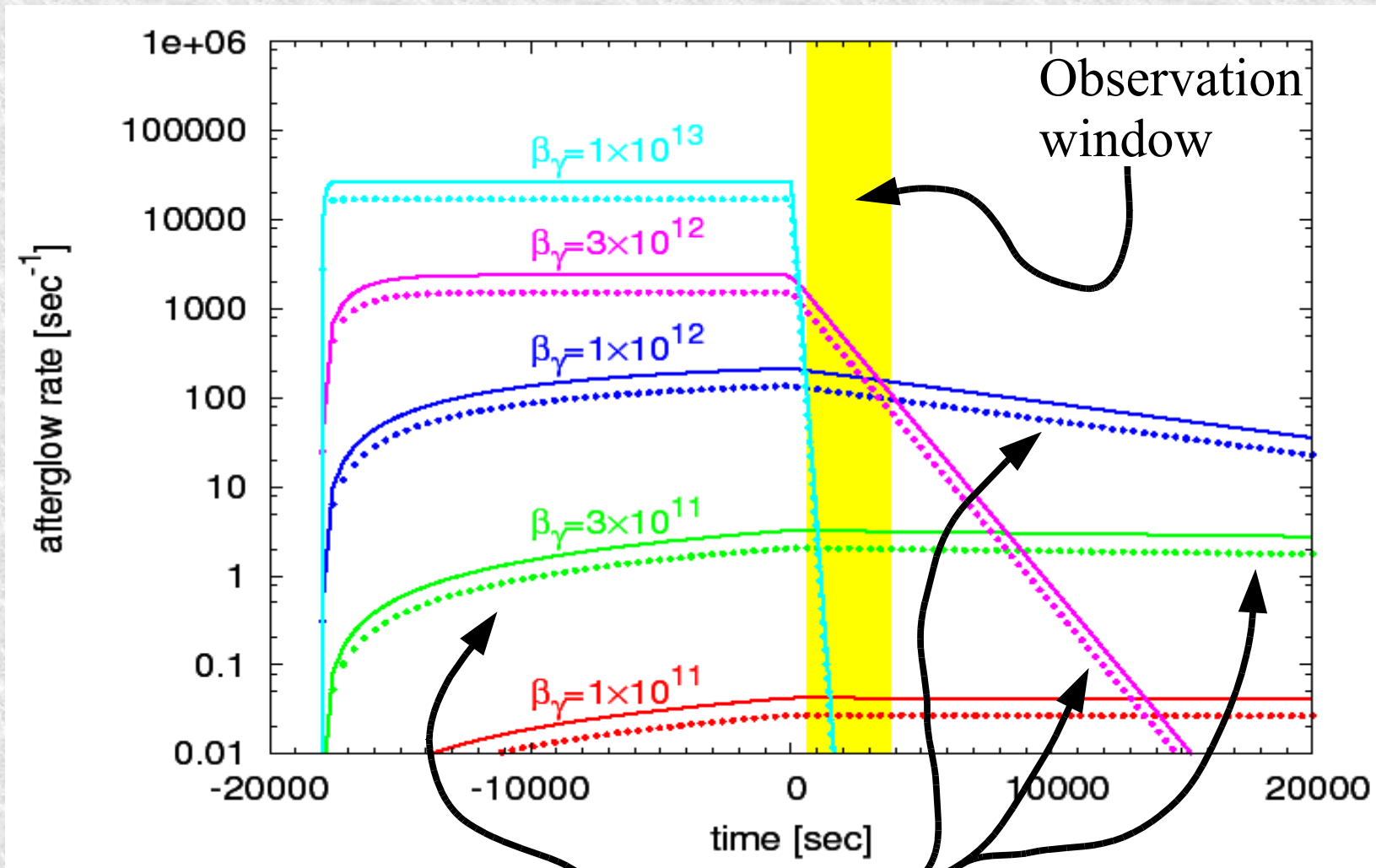

Chameleon population builds during the filling stage

Constrain coupling that are neither too large nor too small

GammeV – Chameleon: Concept

- Chameleon aspect was part of the original **GammeV** objectives
- Use existing equipment and experimental setup
- Fill the cavity for 5 hours in each of the two polarizations
- Collect data for 1 hour in each of the two polarizations

Important Assumptions

- Chameleon self-scattering is negligible and they do not decay into lighter particles over the course of the experiment
- Chameleon particles must reflect off of all solid surfaces and the region between the vacuum pumps
- Chameleon particles cannot stick to the walls

GammeV – Chameleon: Results

Configuration	Fill Time (s)	# photons	Vacuum (Torr)	Observation (s)	Offset (s)	Mean Rate (Hz)
Pseudoscalar	18324	2.39e23	2e-7	3602	319	123
Scalar	19128	2.60e23	1e-7	3616	1006	101

Bouncing trajectories give model dependent regeneration rates

- Assume maximal photon conversion for upper limit on photon coupling (photons escape before observation)
- Assume minimal photon conversion for lower limit on photon coupling (photon rate below detection threshold)

GammeV – Chameleon: Results

Configuration	Fill Time (s)	# photons	Vacuum (Torr)	Observation (s)	Offset (s)	Mean Rate (Hz)
Pseudoscalar	18324	2.39e23	2e-7	3602	319	123
Scalar	19128	2.60e23	1e-7	3616	1006	101

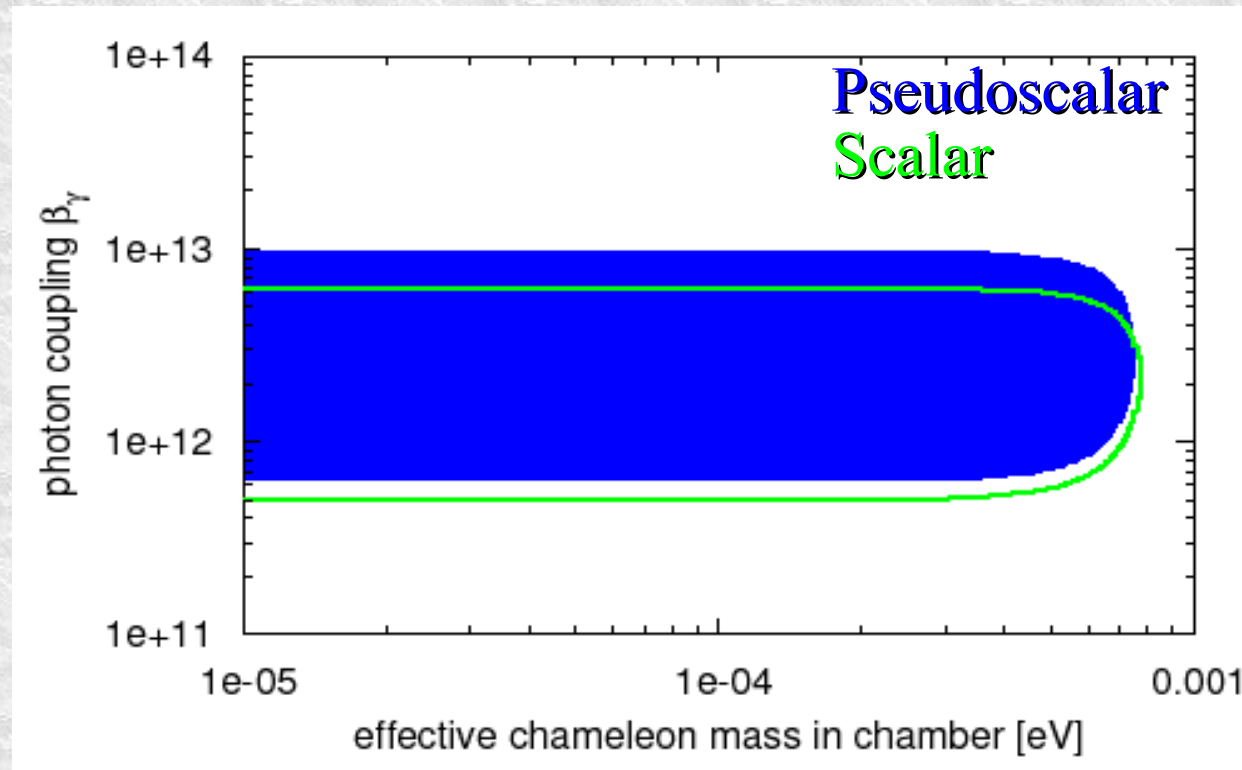

Detector systematic uncertainty dominates; we exclude models which would produce signals larger than 36Hz for $\alpha \gtrsim 0.8$.

GammeV – Plans for the future

Improved chameleon
afterglow experiment.

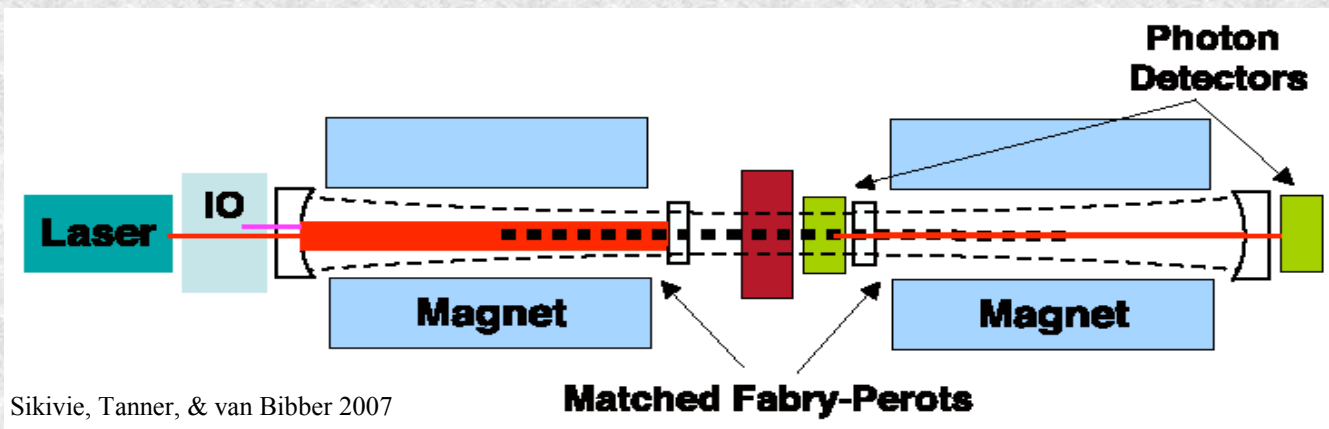
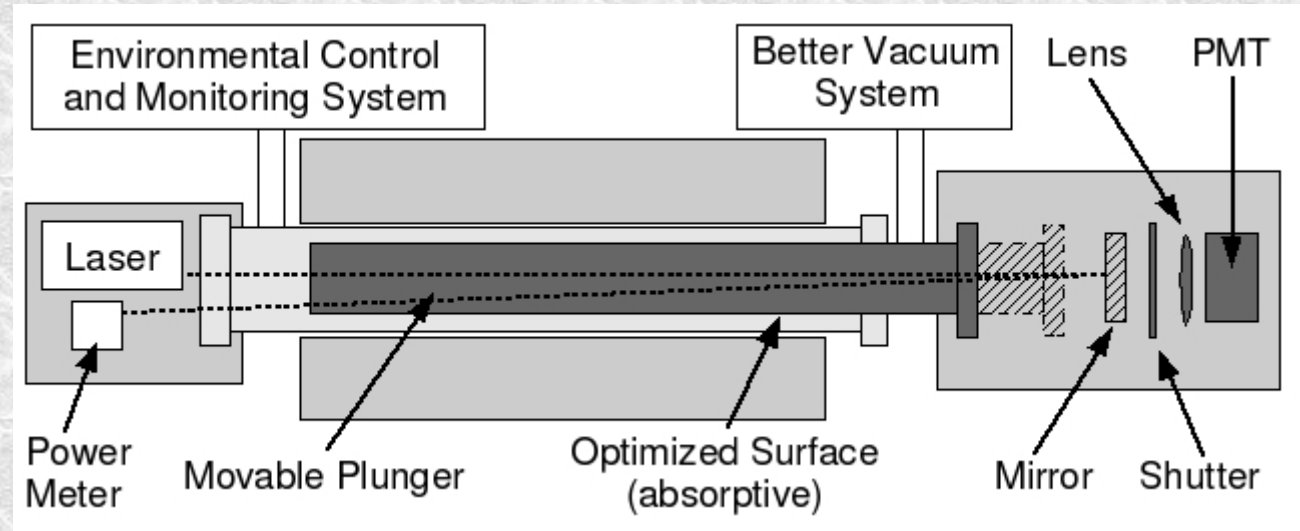

Resonantly enhanced
LSW experiment.

Conclusions

- **GammeV** Axion search excludes the particle interpretation of the PVLAS signal at more than 5-sigma.
 - Variable baseline and pulsed laser are key aspects of the experiment
- **GammeV** Chameleon search can probe interesting chameleon models
 - First application of the particle-in-a-jar method
- Improved experiments for both axions and chameleons are under development.

Axion results: PRL 100, 080402, (2008). arXiv:0710.3783

Chameleon results: PRL Submitted (2008). arXiv:0806.2438